

**DIN 6899 FORM B WIRE ROPE THIMBLE**

	Item	Size/mm	B/mm	H/mm	D/mm
	TDB003	2.5	3	19	12
	TDB004	3.5	4	21	13
	TDB005	4	5	23	14
	TDB006	5	6	25	16
	TDB007	6	7	28	18
	TDB008	7	8	32	20
	TDB009	8	9	35	22
	TDB010	9	10	38	24
	TDB011	10	11	41	26
	TDB012	11	12	45	28
	TDB013	12	13	48	30
	TDB014	13	14	51	32
	TDB015	14	15	54	34
	TDB016	15	16	58	36
	TDB017	16	17	61	38
	TDB018	17	18	64	40
	TDB020	18	20	72	45
	TDB022	20	22	80	50
	TDB024	22	24	90	56
	TDB026	24	26	99	62
	TDB028	26	28	112	70
	TDB030	28	30	120	75
	TDB032	30	32	128	80
	TDB034	32	34	152	95
	TDB036	34	36	160	100
	TDB038	36	38	176	110
	TDB040	38	40	184	115
	TDB042	40	42	192	120
	TDB045	42	45	240	150

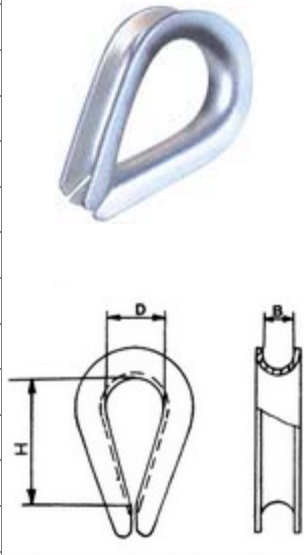
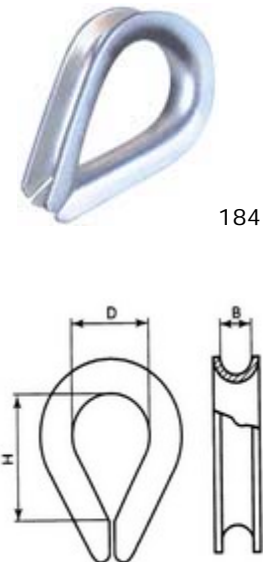

**EUROPEAN TYPE WIRE ROPE THIMBLE**

	Item	Size/mm	B/mm	H/mm	D/mm
	TET003	3	3	16	10
	TET004	4	4	17	11
	TET005	5	5	20	13
	TET006	6	6	25	16
	TET007	7	7	28	18
	TET008	8	8	32	20
	TET010	10	10	40	26
	TET012	12	12	45	28
	TET014	14	14	56	34
	TET016	16	16	72	37
	TET018	18	18	65	42
	TET020	20	20	78	45
	TET022	22	22	88	50
	TET024	24	24	96	58
TET026	26	26	105	66	

**K2 THIMBLE**

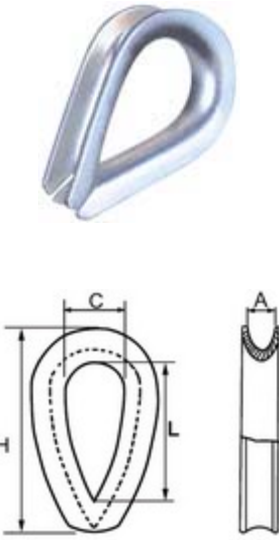
	Item	SIZE/mm	A/mm	C/mm	H/mm	L/mm
	TK2008	8	8	22	51	35
	TK2010	10	10	30	64	47
	TK2012	12	12	35	76	57
	TK2014	14	14	45	89	65
	TK2016	16	16	50	102	76
	TK2018	18	18	53	114	86
	TK2020	20	20	60	127	94
	TK2022	22	22	65	140	107
	TK2024	24	24	70	152	114
	TK2028	28	28	80	178	130
	TK2032	32	32	100	203	157
	TK2036	36	36	115	229	177
	TK2040	40	40	120	254	198
	TK2044	44	44	130	279	214
	TK2050	50	50	140	305	215
	TK2056	56	56	160	356	245
	TK2064	64	64	180	407	275

**HEAVY DUTY WIRE ROPE THIMBLE DIN 3090**

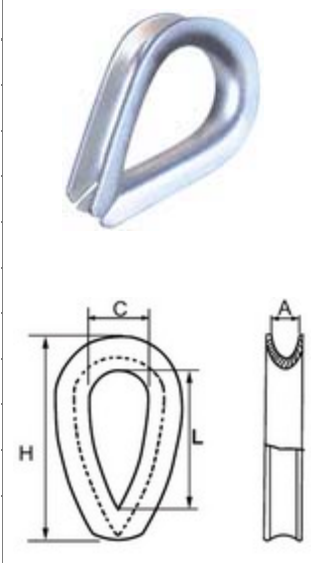
	Item	SIZE/mm	A/mm	C/mm	H/mm
	TDI010	10	11	25	50
	TDI012	12	13	30	60
	TDI014	14	16	35	70
	TDI016	16	18	40	80
	TDI018	18	20	45	90
	TDI020	20	22	50	100
	TDI022	22	24	55	110
	TDI024	24	26	60	120
	TDI026	26	29	65	130
	TDI028	28	31	70	140
	TDI032	32	35	80	160

**BS464 WIRE ROPE THIMBLE**

	Item	Size/inch (Dia of Rope)	Size/mm (Dia. of Rope)	A/mm	B/mm	C/mm min.	D/mm	E/mm	F/mm min.	G/mm	K/mm min.	Q/mm
	T46408	5/16	8	22.2	38	12.7	33.4	52	7.9	4	4	30.1
	T46409	3/8	9	25.4	47.6	14.3	38	64	10.3	6.3	4.8	35
	T46411	7/16	11	28.6	52	17.5	41.3	73	12.7	7.9	4.8	38
	T46413	1/2	13	31.7	58.8	20.6	44.5	79.4	14.3	7.9	5.5	42.9
	T46414	9/16	14	31.7	58.8	20.6	44.5	79.4	14.3	7.9	5.5	42.9
	T46416	5/8	16	41.3	74.5	22.2	58.8	95.8	15.9	8.7	7.9	56
	T46417	11/16	17	44.5	79.4	28.6	66.6	108	19	9.5	7.9	60.4
	T46419	3/4	19	50.8	92	28.6	73	124	20.6	11.1	9.5	69.8
	T46421	13/16	21	50.8	92	28.6	73	121	20.6	11.1	9.5	69.8
	T46422	7/8	22	56	102	31.7	82.5	131	22.2	12.7	9.5	76.2
	T46424	15/16	24	64	110	33.4	92	146	25.4	12.7	10.3	84
	T46425	1	25	69.8	119	35	108	162	27	14.3	10.3	90.5
	T46429	1-1/8	29	76.2	133	38	112	178	28.6	15.9	12.7	102
	T46432	1-1/4	32	95	152	41.3	133	197	33.4	15.9	12.7	121
	T46435	1-3/8	35	105	175	47.6	152	228	38	19	15.9	137
	T46438	1-1/2	38	114	197	52	165	254	41.3	23.8	17.5	149
	T46441	1-5/8	41	114	197	55.6	165	254	42.9	23.8	17.5	149
	T46444	1-3/4	44	127	228	56	178	286	50.8	25.4	25.4	178
	T46448	1-7/8	48	133	248	66.6	190	317	60.4	28.6	25.4	190
T46451	2	51	140	257	69.8	203	330	64	30.1	28.6	197	

T46454	2-1/8	54	140	257	69.8	203	330	64	30.1	28.6	197
T46457	2-1/4	57	146	296	76.2	216	356	66.6	31.7	30.1	206
T46464	1-1/2	64	159	311	95	242	414	69.8	44.5	31.7	222

**U.S. TYPE EXTRA HEAVY DUTY WIRE ROPE THIMBLE**

	Item	Size (inch)	N.W. lbs/100pcs	Item	Size (inch)	N.W. lbs/100pcs
	THD006	1/4	6.75	THD022	7/8	175
	THD008	5/16	11.25	THD026	1	275
	THD010	3/8	30	THD032	1-1/4	400
	THD011	7/16	51	THD036	1-3/8	817
	THD012	1/2	51	THD038	1-1/2	1175
	THD013	9/16	75	THD042	1-5/8	1700
	THD016	5/8	75	THD045	1-3/4	1775
THD019	3/4	147	THD050	2	2500	

**U.S. TYPE STANDARD WIRE ROPE THIMBLE**

	Item	Size (inch)	N.W. lbs/100pcs	Item	Size (inch)	N.W. lbs/100pcs
	TLD003	1/8	2.5	TLD019	3/4	50
	TLD004	3/16	2.5	TLD022	7/8	85
	TLD006	1/4	3.75	TLD026	1	100
	TLD008	5/16	3.75	TLD032	1-1/4	175
	TLD009	3/8	6.28	TLD038	1-1/2	340
	TLD013	1/2	12.5	TLD045	1-3/4	594
TLD016	5/8	25				

**U.S. TYPE GUSSETED HEAVY DUTY WIRE ROPE THIMBLE**

	Item	Size (inch)	N.W. lbs/100pcs	Item	Size (inch)	N.W. lbs/100pcs
	TGH006	1/4	7.7	TGH019	3/4	158
	TGH008	5/16	14	TGH022	7/8	197
	TGH010	3/8	27	TGH026	1	312
	TGH012	1/2	56	TGH032	1-1/4	429
	TGH016	5/8	81	TGH038	1-1/2	1233

**ROUND THIMBLE**

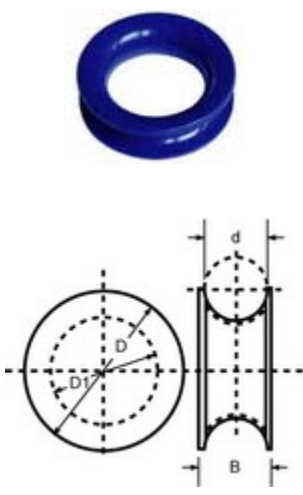
	Item	SIZE/mm	B/mm	D/mm	D1/mm
	RTD008	8	11	22	12
	RTD010	10	13	28	16
	RTD012	12	15	34	18
	RTD014	14	17	38	20
	RTD016	16	19	42	3
	RTD018	18	21	50	26
	RTD020	20	23	55	28
	RTD022	22	25	60	30
	RTD024	24	27	65	34
	RTD026	26	30	70	36
	RTD028	28	32	75	40
	RTD030	30	34	80	42
	RTD032	32	36	86	44
	RTD035	35	41	92	48
	RTD040	40	46	105	55

**STAINLESS STEEL EXTRA HEAVY DUTY WIRE ROPE THIMBLE U.S. TYPE**

	ART. NO.	SIZE/INCH	N.W./KGS
	S-T0006	1/4	0.028
	S-T0008	5/16	0.054
	S-T0010	3/8	0.107
	S-T0011	7/16	0.147
	S-T0013	1/2	0.240
	S-T0014	9/16	0.240
	S-T0016	5/8	0.330
	S-T0019	3/4	0.690
	S-T0022	7/8	0.830
	S-T0025	1	1.200

**STAINLESS STEEL STANDARD WIRE ROPE THIMBLE U.S. TYPE**

	ART. NO.	SIZE/INCH	N.W./KGS
	S-T1003	1/8	0.015
	S-T1005	3/16	0.015
	S-T1006	1/4	0.015
	S-T1008	5/16	0.019
	S-T1010	3/8	0.031

S-T1013	1/2	0.060
S-T1016	5/8	0.167
S-T1019	3/4	0.262
S-T1022	7/8	0.403
S-T1025	1	0.476

**STAINLESS STEEL EUROPEAN COMMERCIAL THIMBLE**

	ART. NO.	SIZE/MM	N.W./KGS/100PCS
	S-T2003	3	0.38
	S-T2004	4	0.53
	S-T2005	5	0.70
	S-T2006	6	0.96
	S-T2008	8	2.05
	S-T2010	10	3.30
	S-T2012	12	5.50
	S-T2014	14	10.30
	S-T2016	16	12.40
	S-T2020	20	26.60
	S-T2022	22	32.60
	S-T2024	24	45.10
	S-T2028	28	73.90

**STAINLESS STEEL ITALIAN COMMERCIAL THIMBLE**

	ART. NO.	SIZE/MM	N.W./KGS/100PCS
	S-T020	2	0.11
	S-T025	2.5	0.15
	S-T030	3	0.38
	S-T040	4	0.53
	S-T050	5	0.70
	S-T060	6	0.96
	S-T080	8	2.10
	S-T100	10	3.30
	S-T120	12	5.50
	S-T140	14	10.30
	S-T160	16	12.40
	S-T180	18	16.00
	S-T200	20	26.60
	S-T220	22	32.60
	S-T240	24	45.10

S-T280	28	73.90
S-T320	32	76.40
S-T360	36	144.90